

WBP-1

End case UPO-line
Gavelgondol U-line

Utgåveförteckning

WBP-1

Illustration	Page	Table of contents
200076	7	Spare part for accessories
200238	3	Basic details, cabinet
200239	5	Design details, cabinet

WBP-1

Table of contents

Basic details, cabinet

Design details, cabinet

Spare part for accessories

Innehållsförteckning

Grunddetaljer, disk

Design detaljer, disk

Reservdelar för tillbehör

Page/Sida

3

5

7

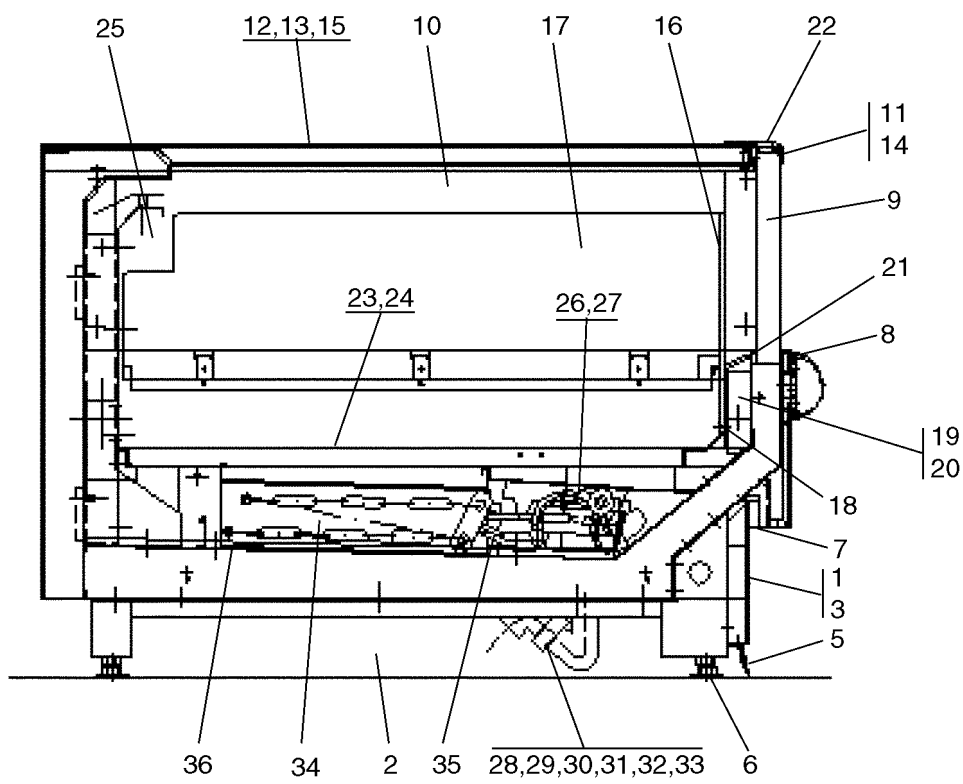

WBP-1

Basic details, cabinet

Illustration	Issue	Month	Year
Illustration	Utgåva	Månad	År
200238/1	1	2	2000

Grunddetaljer, disk

Item Pos.	Qua Ant.	Art.No Art.nr	Description	Benämning	Info Info	Notes Anmärkning
1	1	4660009475401	Basepanel perforated / hole key switcher	Sockel, perforerad med hål för nyckelbrytare	3	L=2160 Choose colour
2	1	4660009475501	Basepanel perforated, left	Sockel perforerad, vänster	3	Choose colour
	1	4660009475502	Basepanel perforated, right	Sockel perforerad, höger	3	Choose colour
3	1	4660009442801	Basepanel holder	Sockelfäste	3	
4	1	4660009474302	Lock key switcher	Plåtlock för nyckelbrytare	3	Choose colour Not showed
5	1	4660009354506	Basepanel coverstrip	Tätninglist sockel	3	L=2210
	2	4660009354507	Basepanel coverstrip	Tätninglist sockel	3	L=1060
6	6	4660009437501	Adjustable foot	Ställfot	3	
7	3	4660009412401	Basepanel holder	Stöd, frontplåt	3	
8	1	466094067047F	Cover plate	Täckplåt	3	L=2135 Grey RAL 7035 Front U-line
9	1	4660009430301	Insulating glass	Isolerglas	1	31x316x2184
10	2	4660009433201	Insulating glass	Isolerglas	1	31x316x932
11	1	4660009433303	Handrail	Al-profil, sarg	3	L=2244
12	1	4660009433301	Handrail	Al-profil, sarg	3	L=1075 Left hand
13	1	4660009433302	Handrail	Al-profil, sarg	3	L=1075 Right hand
14	1	4660009277603	Heating wire	Värmetråd	1	59W/230V Silicon
15	2	4660009277501	Heating wire	Värmetråd	1	24W/230V Silicon
16	1	4660009425902	Plexi glass front	Frontplexi	3	6x330x1066 Acrylic plastic
17	2	4660009430701	Plexi glass side	Sidoplexi	3	6x250x890 Acrylic plastic
18		4660009410303	Holder frontplexi	Stödlister för frontplexi	3	L=2134 White
19	1	4660622101814	Thermometer	Distanstermometer	1	
20	1	4660009410701	Thermometer holder	Termometerfäste	3	
21	1	4660009410603	Return air grid	Returluftgaller	3	L=2134 White
22	2	4660009430401	Plastic corners	Plasthorn	3	Black
23	3	4660009411702	Bottom shelf	Bottenhylla	3	600x828 White Without hole
24	1	4660009411704	Bottom shelf	Bottenhylla	3	240x828 White With hole
25	1	4660009429701	Exhaust screen compl	Ryggskärm, komplett	3	Incl. air guide
26	2	4660009427201	Fan motor	Fläktmotor	1	10/20 Incl fan motor ring 154
27	2	4660082428428	Fan blade	Fläktvinge	1	154 H=28
28	2	4660624411012	Angle connector	Vinkelkoppling	1	32-90 instick
29	1	4660624111411	Coupling sleeve, drain	Skarvkoppling	3	32/40
30	1	4660007391301	Hydraulic lock	Vattenlås	3	
31	1	4660624411212	Angle coupling	Vinkelkoppling	1	40-90 Input
32	1	4660009455609	Plastic pipe	Plaströr	3	32 L=320
33	1	4660009455601	Plastic pipe	Plaströr	3	32 L=90
34	1	4660009431401	Evaporator	Förångare	1	100x400x1836
35	2	4660009426905	Heater Rod	Värmestav	1	1000W/230V Front
36	1	4660009431501	Heater Rod	Värmestav	1	260W/230V Rear

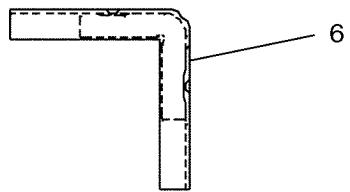
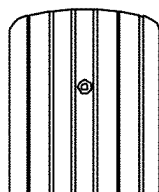
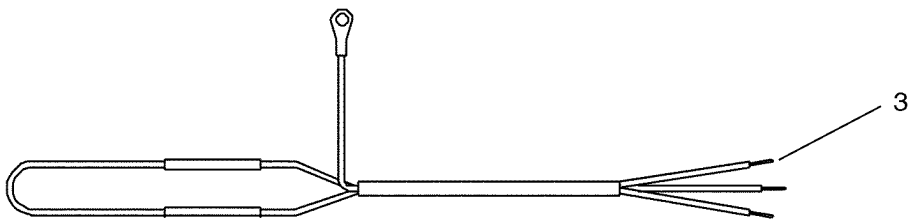
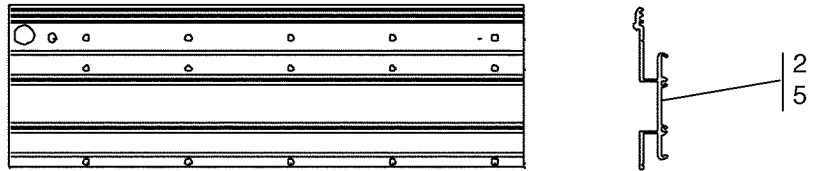
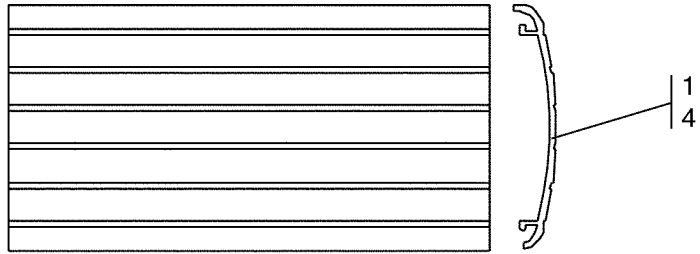

WBP-1

Design details, cabinet

Illustration	Issue	Month	Year
Illustration	Utgåva	Månad	År
200239/1	1	2	2000

Design detaljer, disk

Item Pos.	Qua Ant.	Art.No Art.nr	Description	Benämning	Info Info	Notes Anmärkning
1	1	466084877332T	Bumperprofile Design 7 UPO	Bumperprofil Design 7 UPO	3	L=2210 Blue RAL 5007
	1	466084877334Z	Bumperprofile Design 7 UPO	Bumperprofil Design 7 UPO	3	L=2210 Green RAL 6000
	1	466084877335S	Bumperprofile Design 7 UPO	Bumperprofil Design 7 UPO		L=2210 Red RAL 3031
	1	466084877337F	Bumperprofile Design 7 UPO	Bumperprofil Design 7 UPO	3	L=2210 Grey RAL 7035
	1	466084877338C	Bumperprofile Design 7 UPO	Bumperprofil Design 7 UPO	3	L=2210 Black RAL 5004
2	1	4660009400003	AI-profile, Design UPO	Fästprofil, Design 7 UPO	3	L=2130 AI-profile
3	1	4660009277603	Heating wire	Värmetråd	1	59W/230V Silicon
4	2	466084877132T	Bumperprofile Design 7 UPO	Bumperprofil Design 7 UPO	3	L=1036 Blue RAL 5007
	2	466084877134Z	Bumperprofile Design 7 UPO	Bumperprofil Design 7 UPO	3	L=1036 Green RAL 6000
	2	466084877135S	Bumperprofile Design 7 UPO	Bumperprofil Design 7 UPO	3	L=1036 Red RAL 3031
	2	466084877137F	Bumperprofile Design 7 UPO	Bumperprofil Design 7 UPO	3	L=1036 Grey RAL 7035
	2	466084877138C	Bumperprofile Design 7 UPO	Bumperprofil Design 7 UPO	3	L=1036 Black RAL 5004
5	2	4660008488110	AI-profile, Design UPO	Fästprofil, Design 7 UPO	3	L=1020
6	2	466085094012T	Bumper corner Design 7 UPO	Bumpershörn Design 7 UPO	3	Blue RAL 5007
	2	466085094014Z	Bumper corner Design 7 UPO	Bumpershörn Design 7 UPO	3	Green RAL 6000
	2	466085094015S	Bumper corner Design 7 UPO	Bumpershörn Design 7 UPO	3	L=1007 Red RAL 3031
	2	466085094017F	Bumper corner Design 7 UPO	Bumpershörn Design 7 UPO	3	Grey RAL 7035
	2	466085094018C	Bumper corner Design 7 UPO	Bumpershörn Design 7 UPO	3	Black RAL 5004

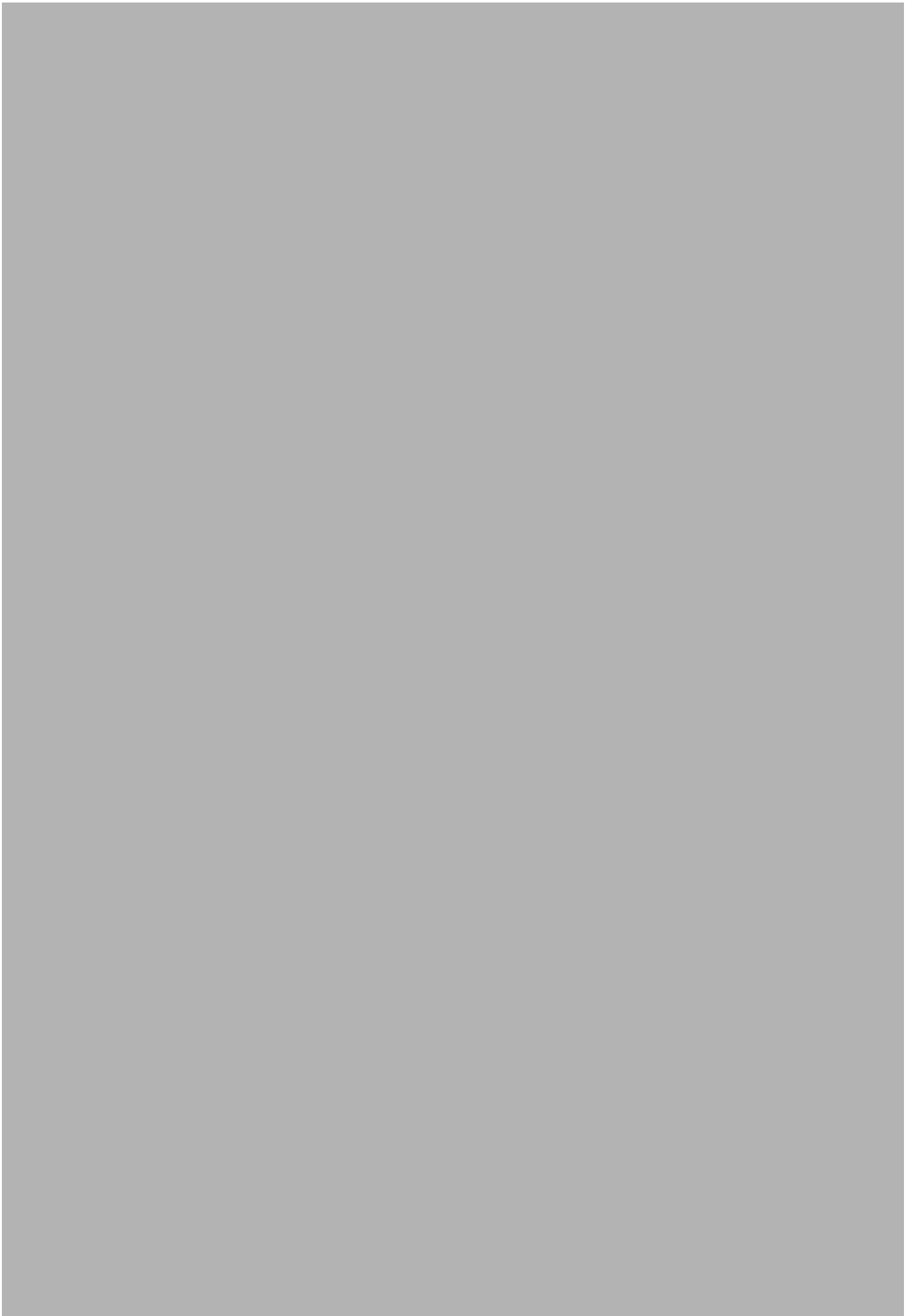

WBP-1

Spare part for accessories

Reservdelar för tillbehör

Illustration	Issue	Month	Year
Illustration	Utgåva	Månad	År
200076/1	1	2	2000

Item Pos.	Qua Ant.	Art.No Art.nr	Description	Benämning	Info Info	Notes Anmärkning
1		4660094731A03	Handrail, compl.	Sarg, kompl	3	Stainless steel



Electrolux Commercial Refrigeration AB, Box 53, SE-360 44 Ingelstad, Sweden
Phone +46 470 734 400, Fax +46 470 734 496

Spareparts Distribution By: Electrolux Wascator Spareparts Division, SE-341 80 Ljungby, Sweden
Phone +46 372 661 00. Fax +46 372 861 75. E-mail: spare.parts@wascator.electrolux.se